

Measurement of Space Charge Accumulation in Dielectric Materials and Analysis using Quantum Chemical Calculation

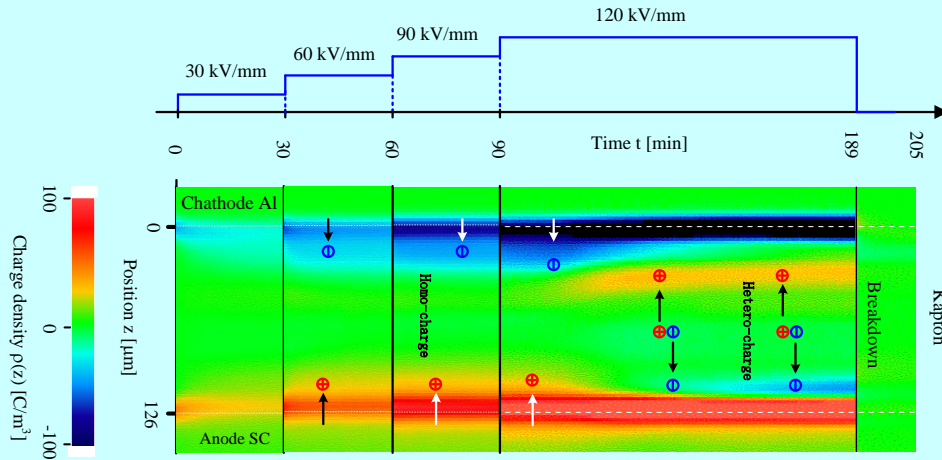

Part 2 PEA measurement

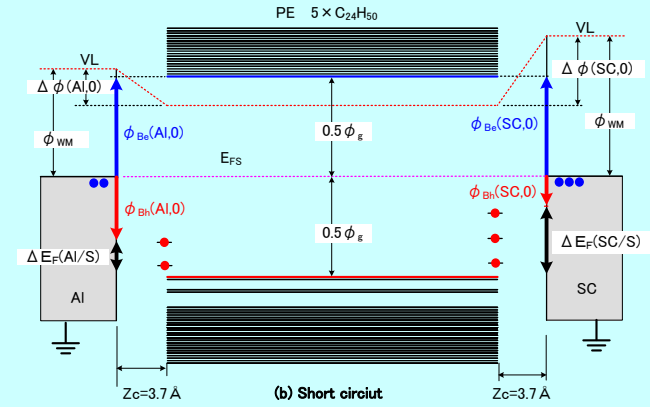

Part 3 Analysis by Quantum Chemical Calculation

Part 1 $Q(t)$ measurement

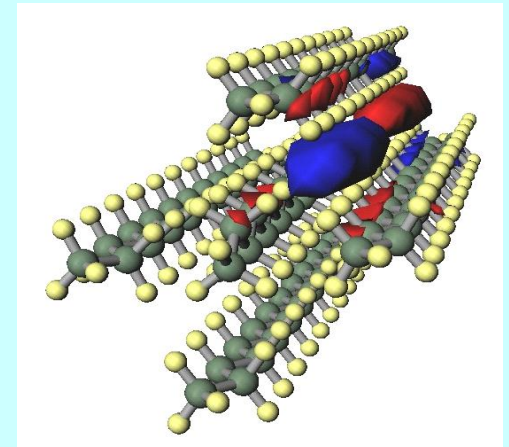
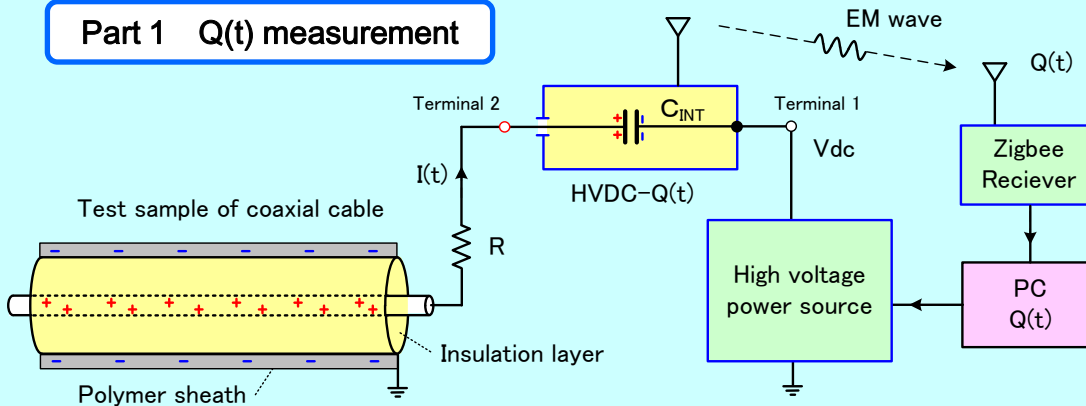

Part 1 Q(t) measurement

< Q(t) Measurement Protocol /Low voltage side >

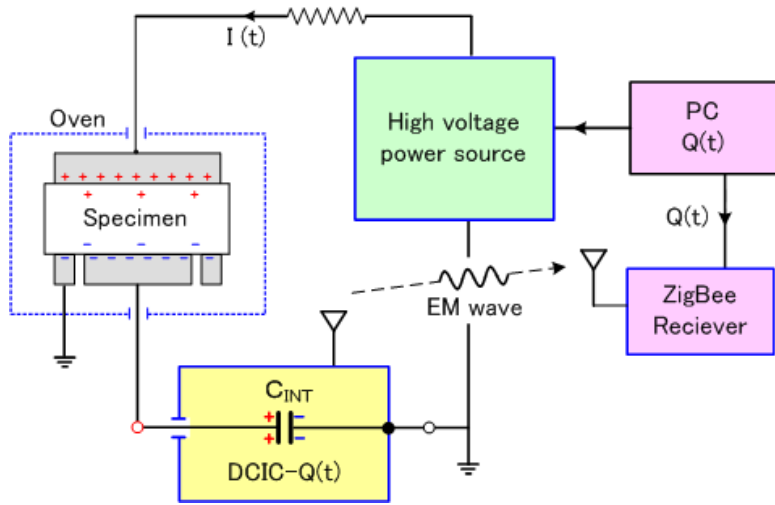

< Q(t) Measurement Protocol /High voltage side >

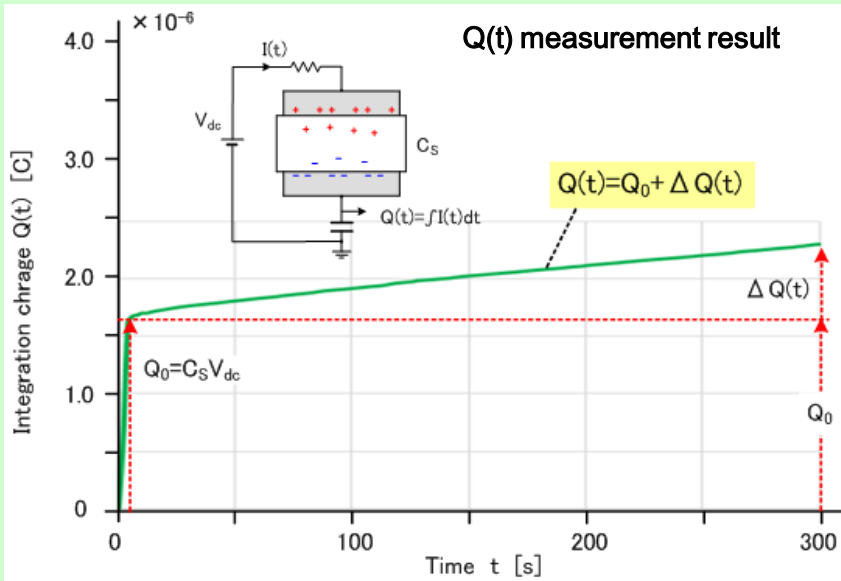
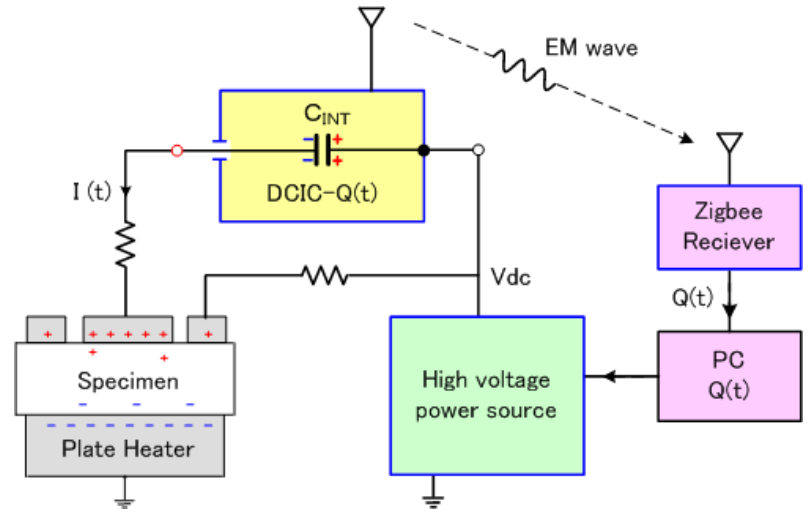

Electric field threshold of charge accumulation

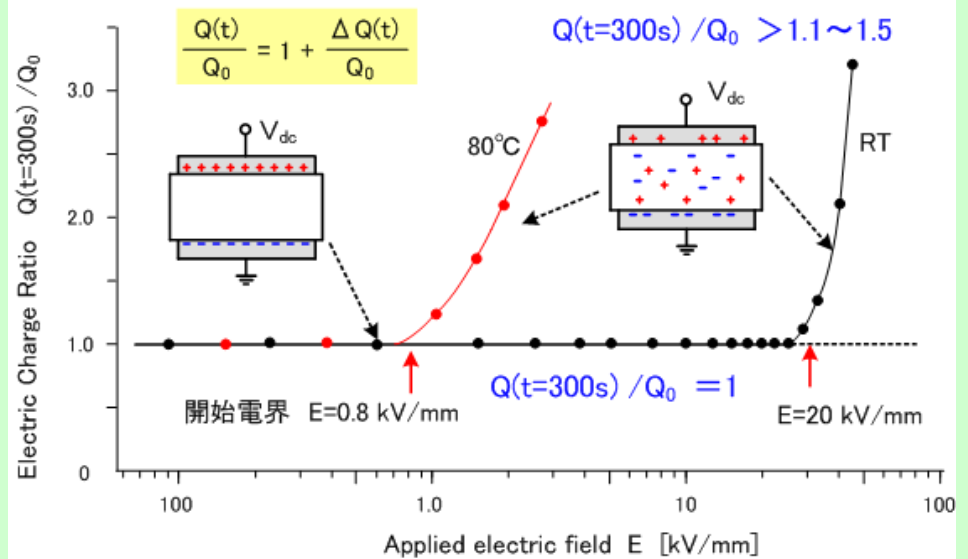

Q(t) measurement results (Difficult for charge accumulation in aromatic polymer)

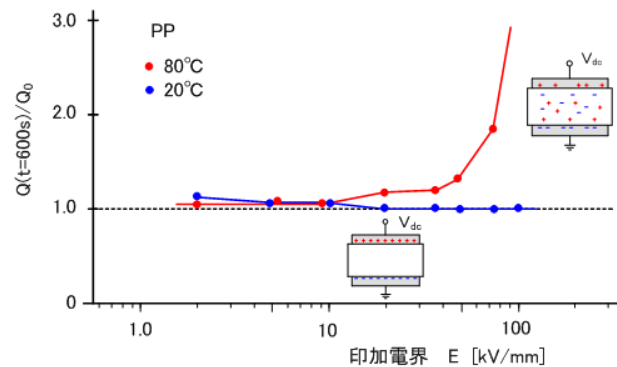
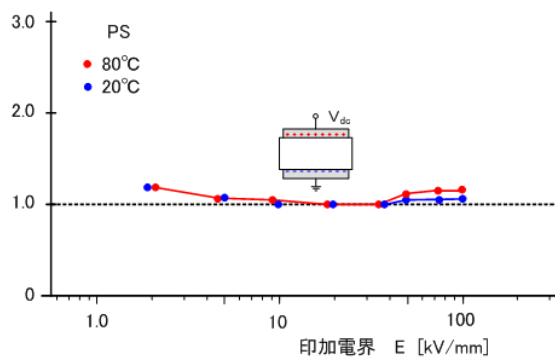
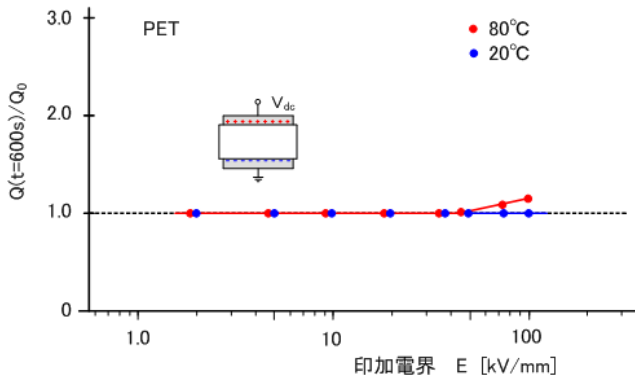
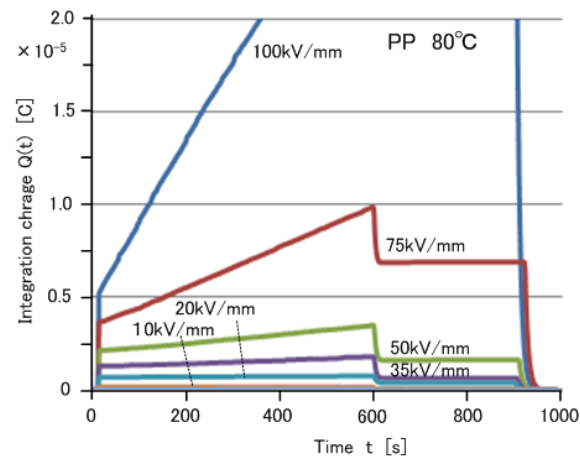
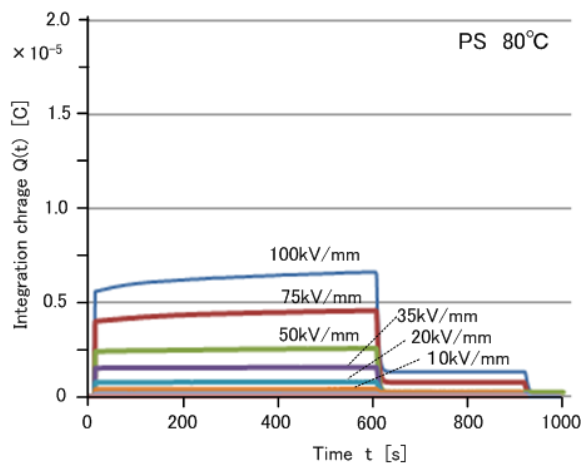
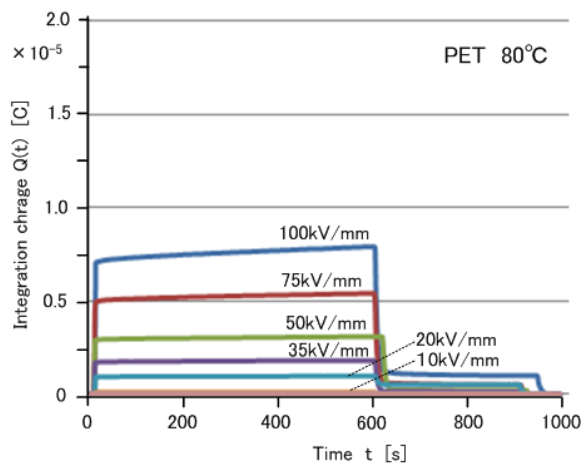
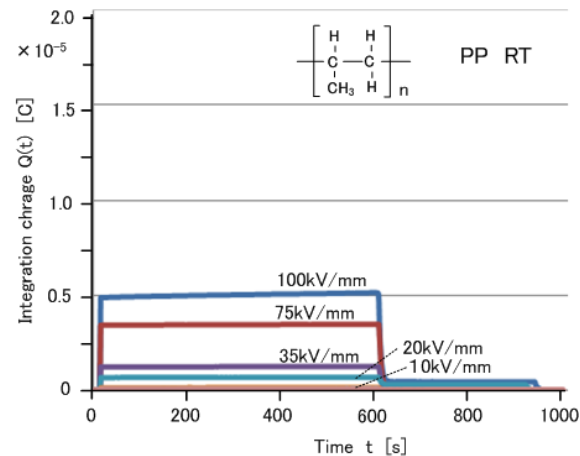
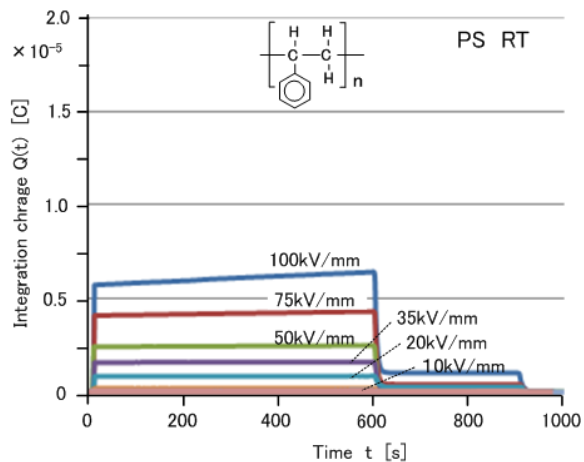
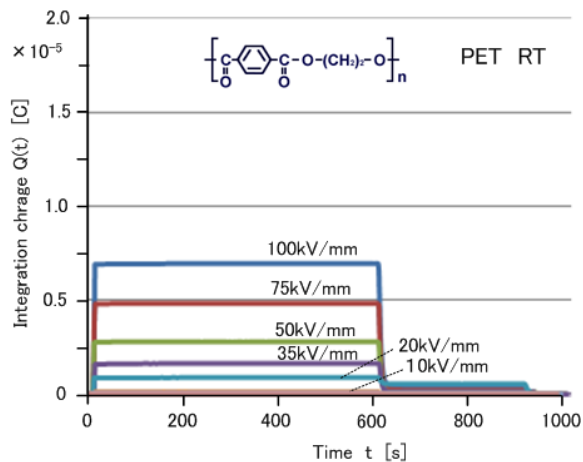

Q(t) measurement results (Easy for charge accumulation in olefin polymer)

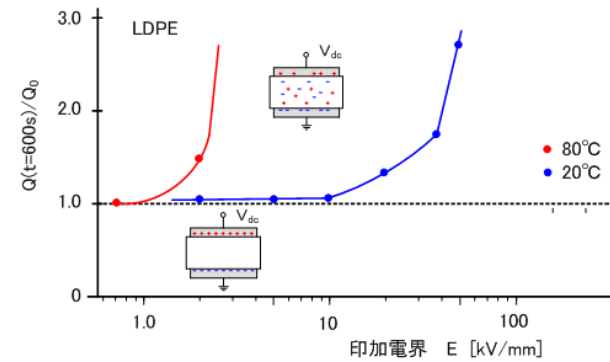
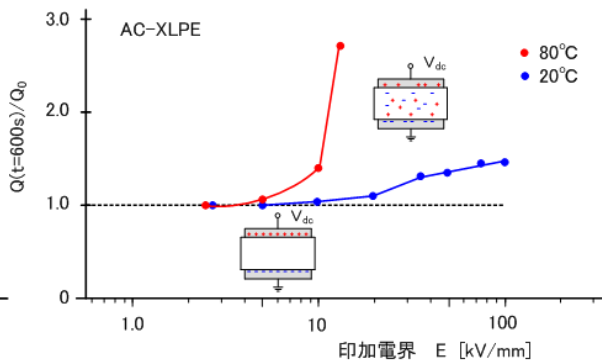
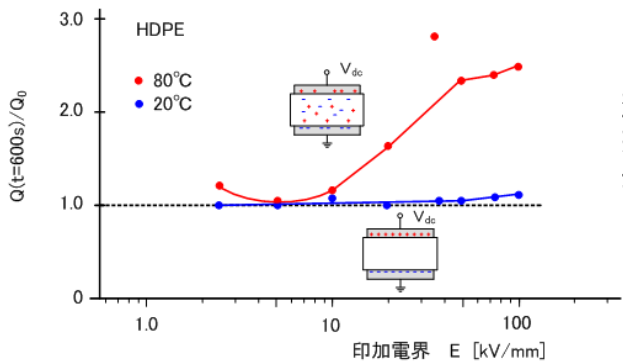
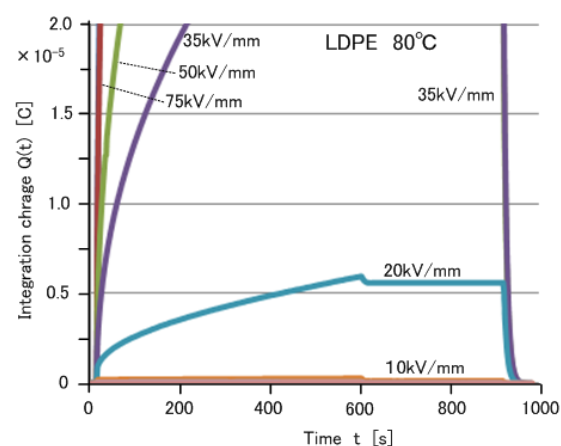
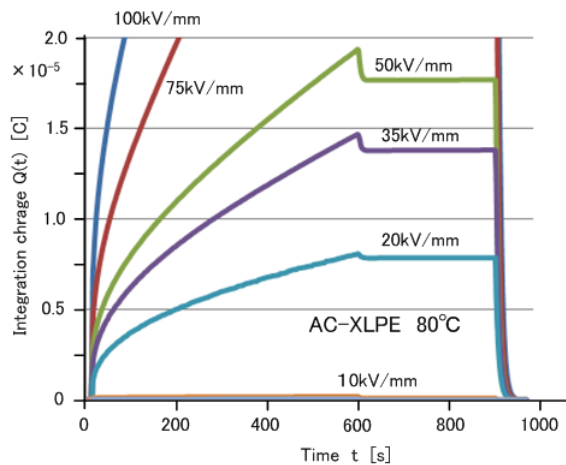
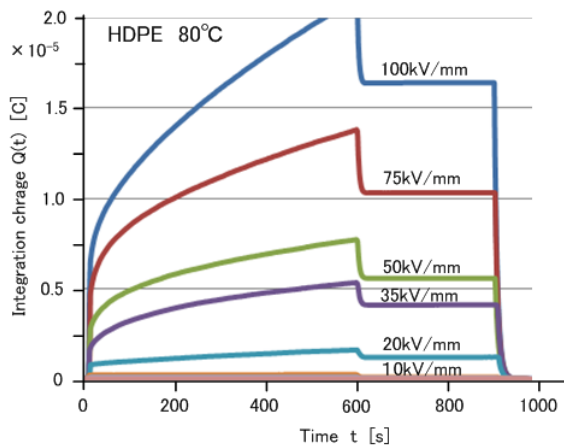
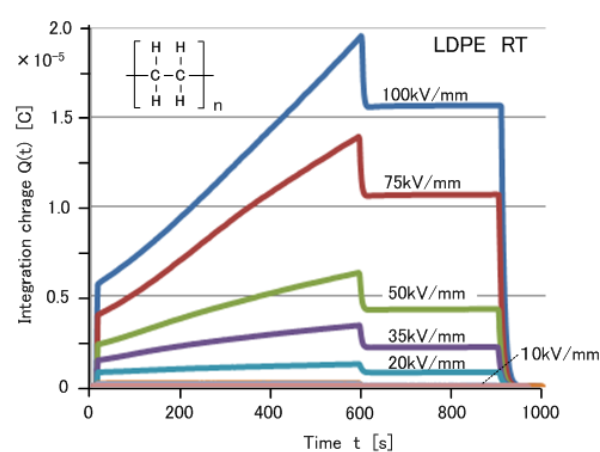
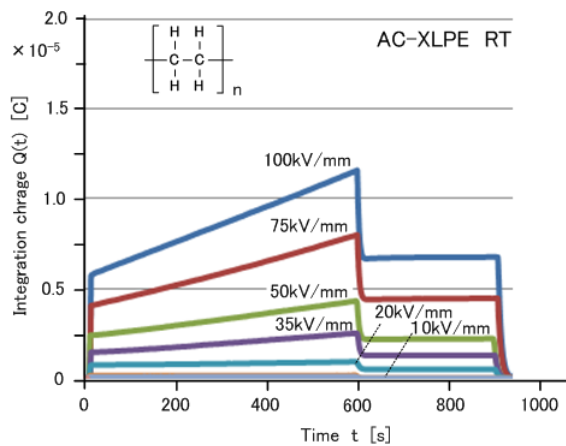
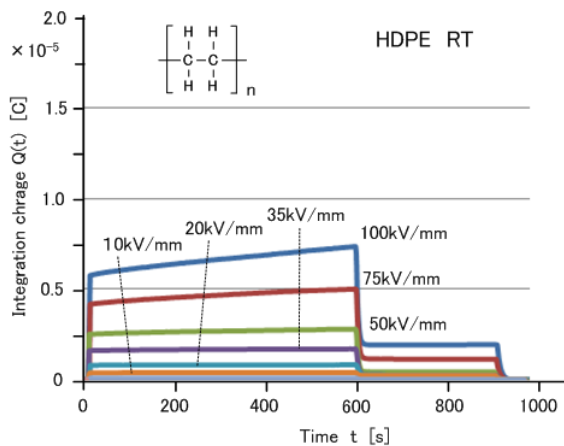

Q(t) Measurement: Water-tree Deteriorated CV Cable

Q(t) device is set on high voltage side

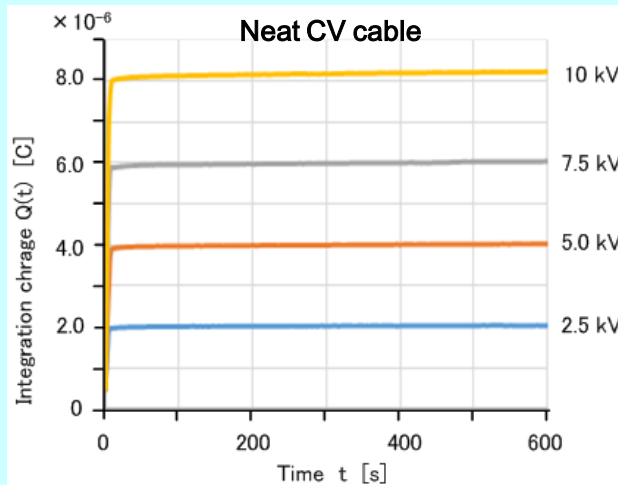
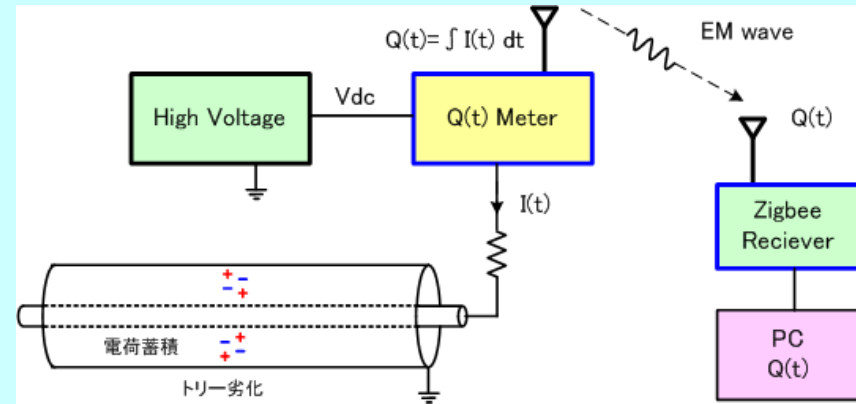

Evaluation on
electric
charge accumulation

No charge
accumulation
→ No deterioration

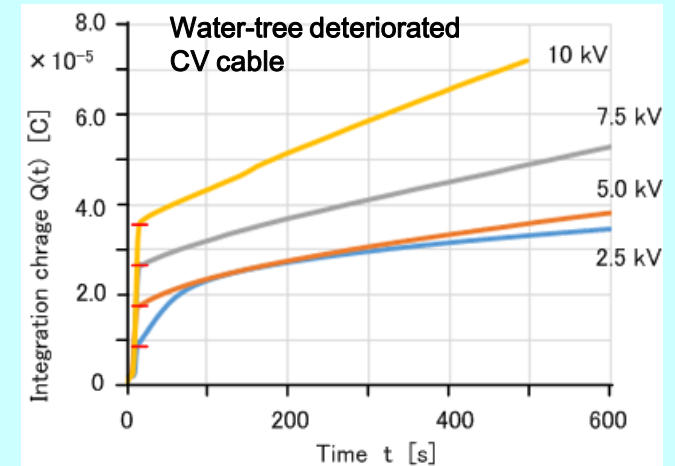

Some charge
accumulation
→ deterioration

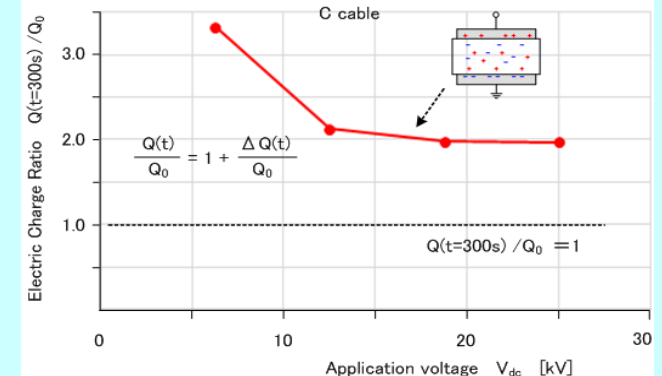
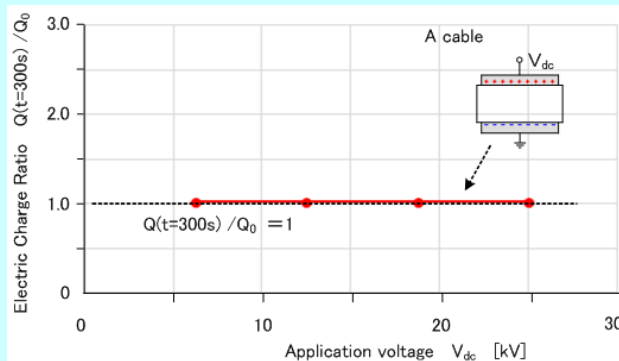

Q(t) Measurement: Gamma-ray irradiated cable

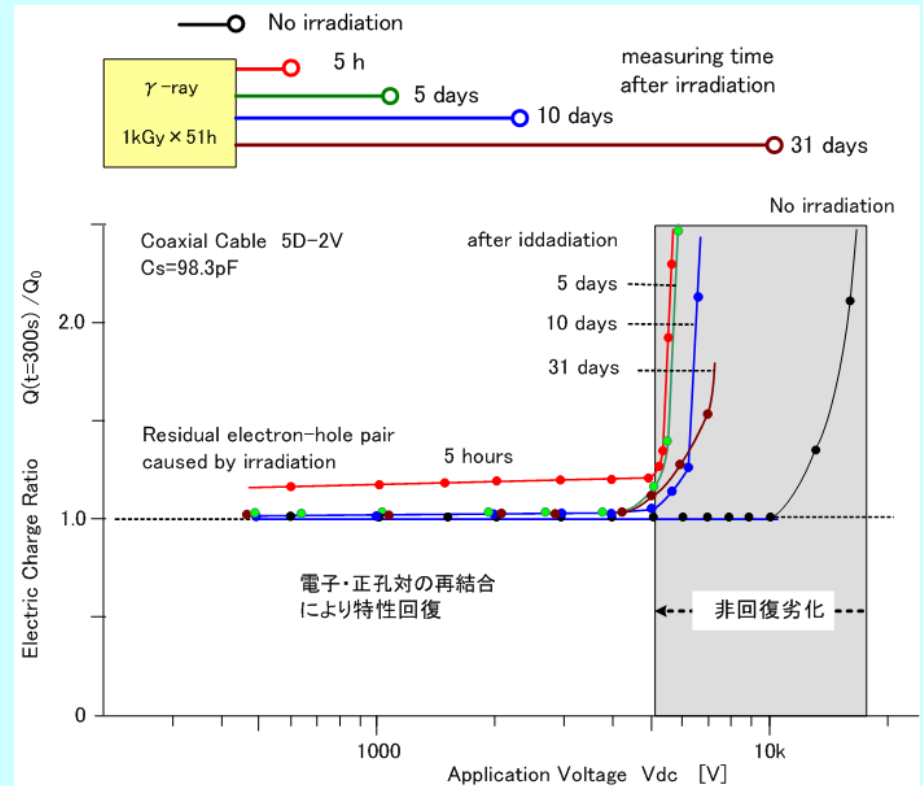
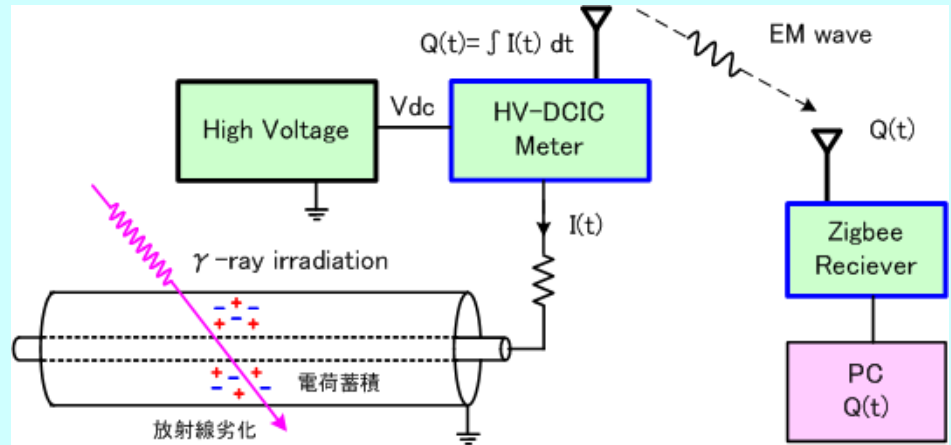
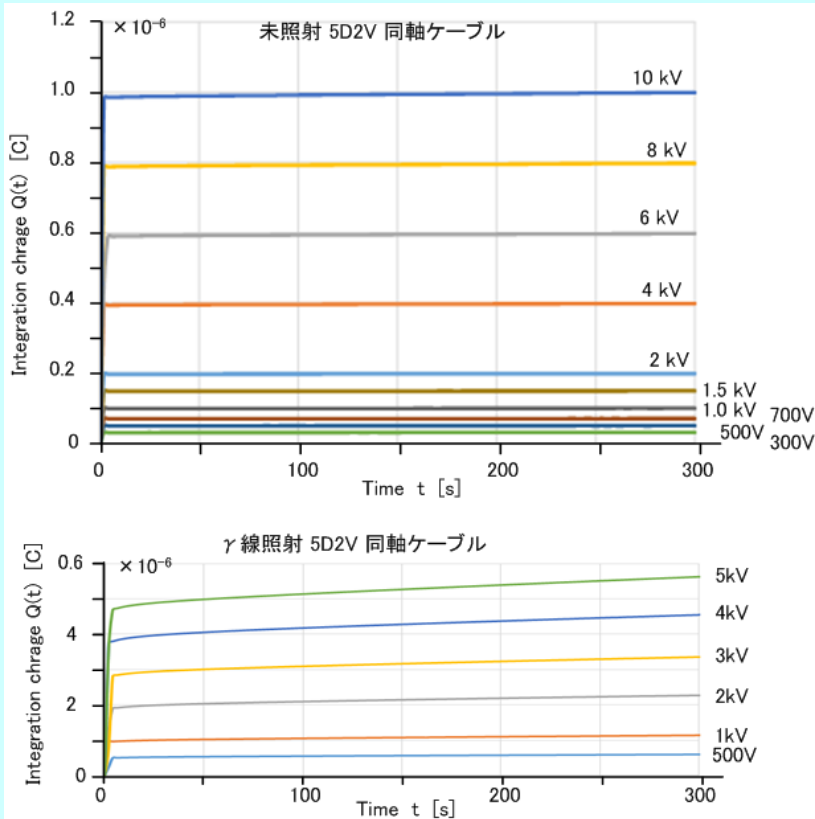

Generation of electron/hole pair by gamma-ray irradiation in cable
→ the electron/hole pair are recombined by the thermal energy and an applied electric field.

Charge Measurement Methods of DC insulating materials

I(t) measurement

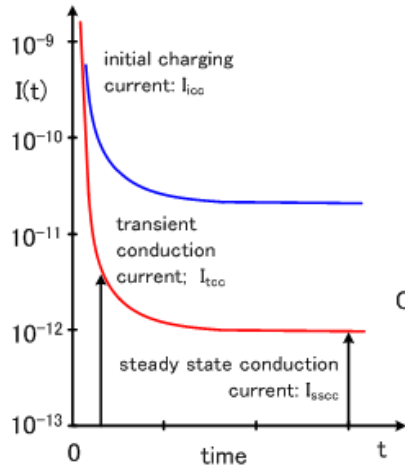

Q(t) measurement

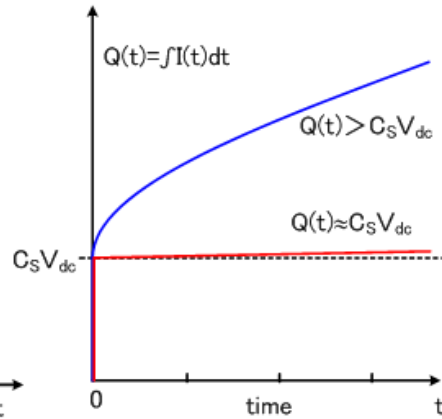

E(0,t) and E(a,t) measurement

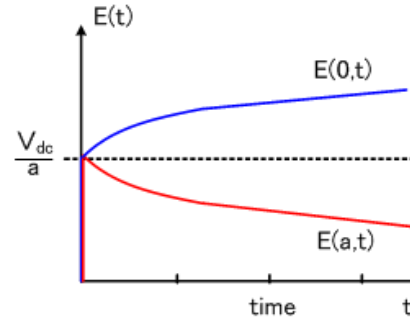

PEA method

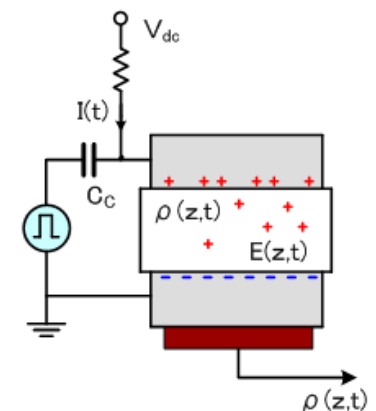
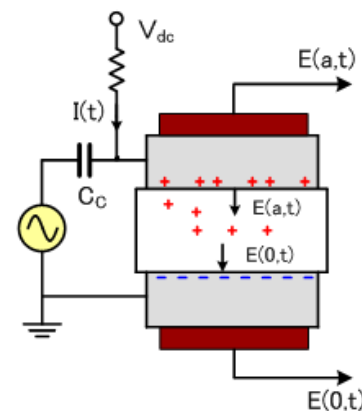
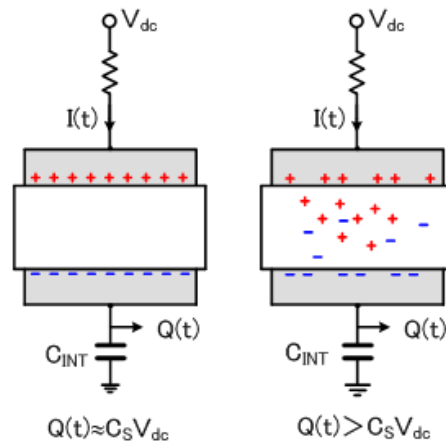
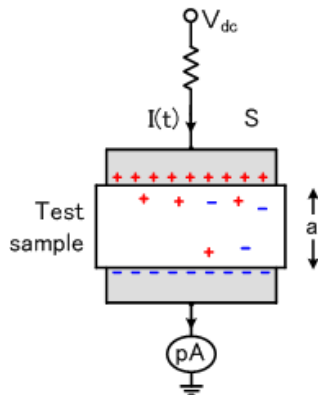
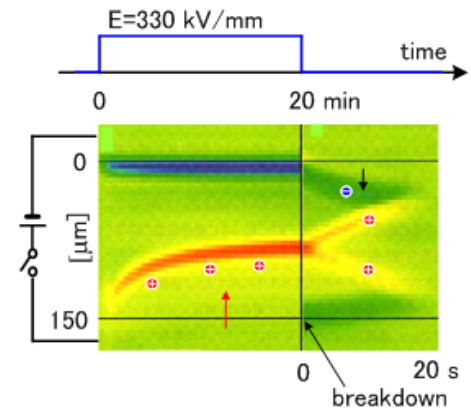

< Q(t) Measurement >

< PEA Method >

Q(t) and PEA give same properties results

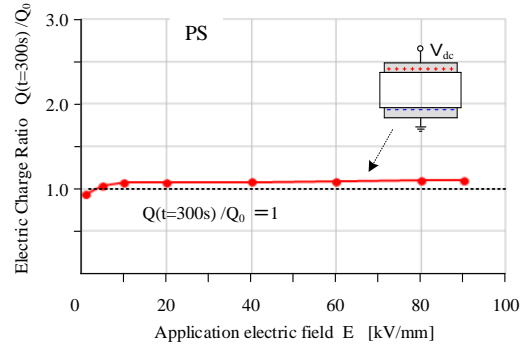
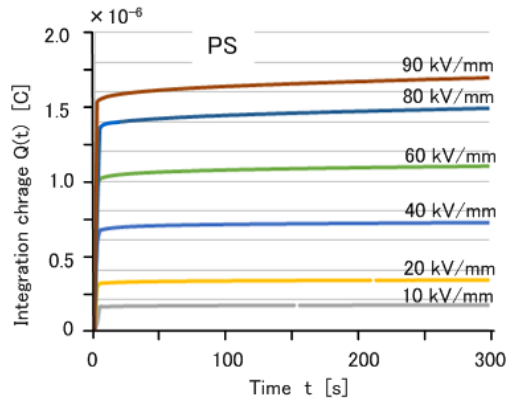

PS (polyethylene) : little charge accumulation.

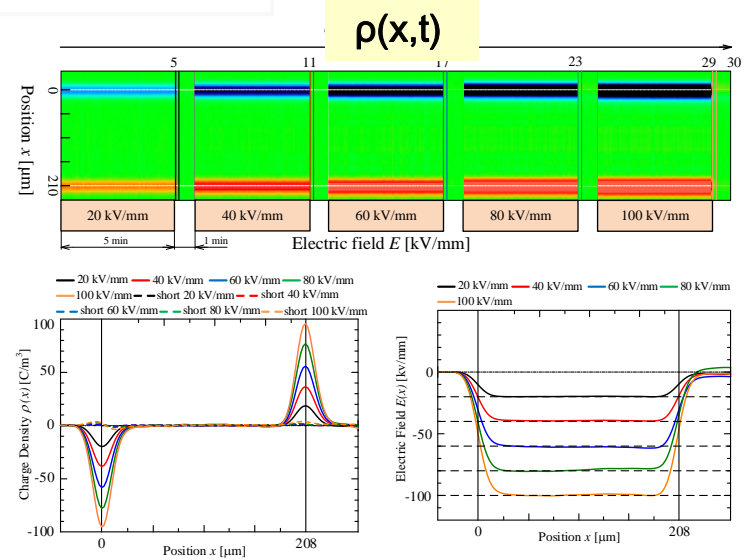

LDPE (low density polyethylene): large amounts of charge accumulation.

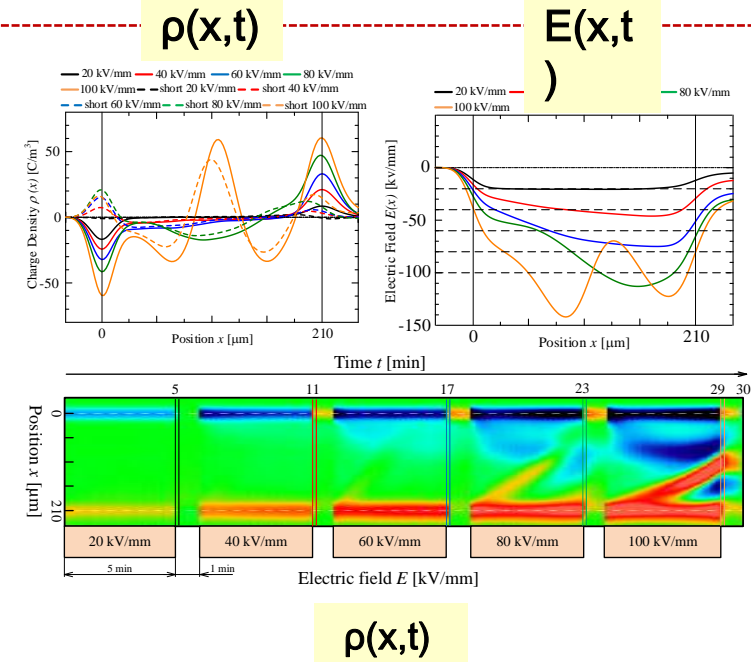
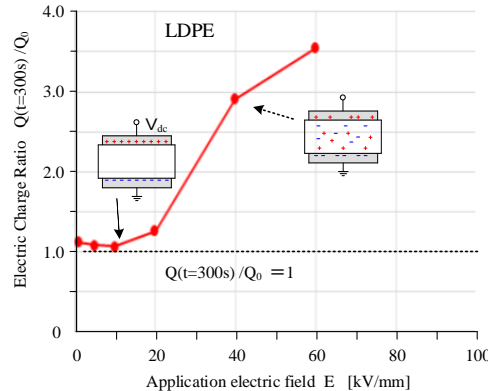
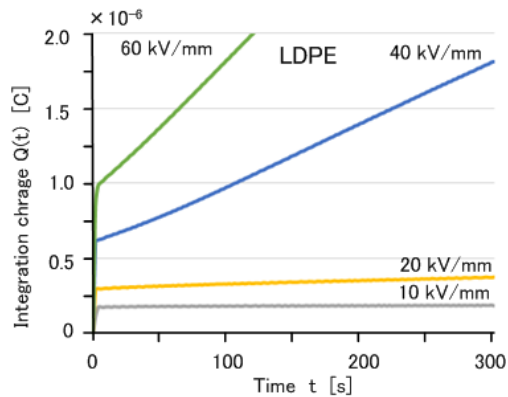

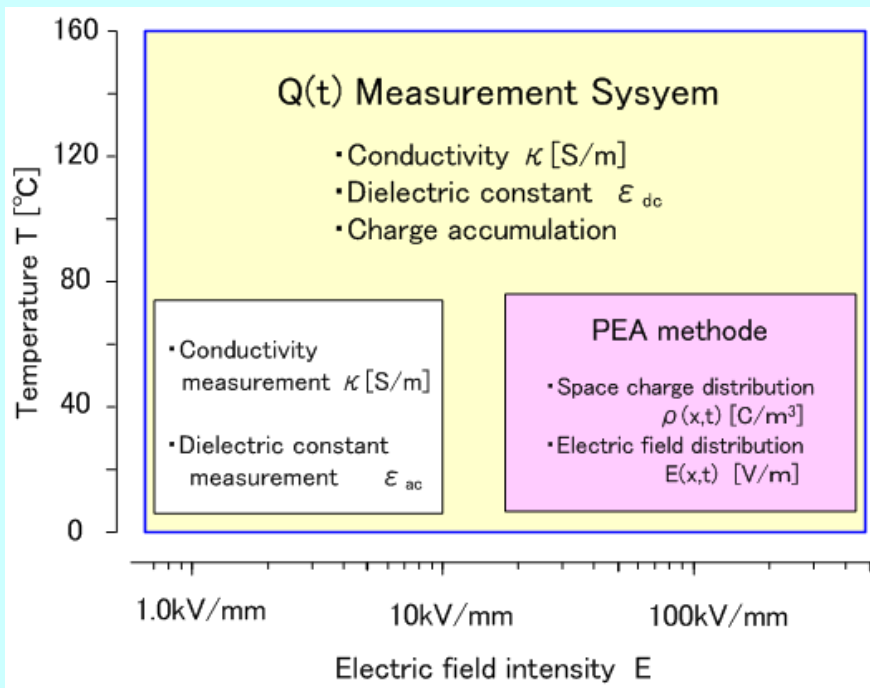

Comparison among various methods of DC insulating material properties

Q(t) method:
wide range of tested temperature and electric stress

Q(t) method

Table Comparison between measurements for electric charge properties

	I(t) measurement	Q(t) method	PEA method
Measurement Principle	Pico-ammeter	Current integration	Electro-acoustic transducer
Space charge distribution	×	×	⊙
Evaluation of charge accumulation	×	⊙	○
Conductivity κ [S/m]	⊙	⊙	×
Dielectric constant ϵ_r	×	⊙	×

Part 2 PEA measurement

A : Research Subjects on HVDC Electrical Insulation

• Internal electric field distortion caused by charge accumulation leads to an electrical breakdown of insulating materials

• Electric charge accumulation is one of significant factor for studying the properties of insulating materials

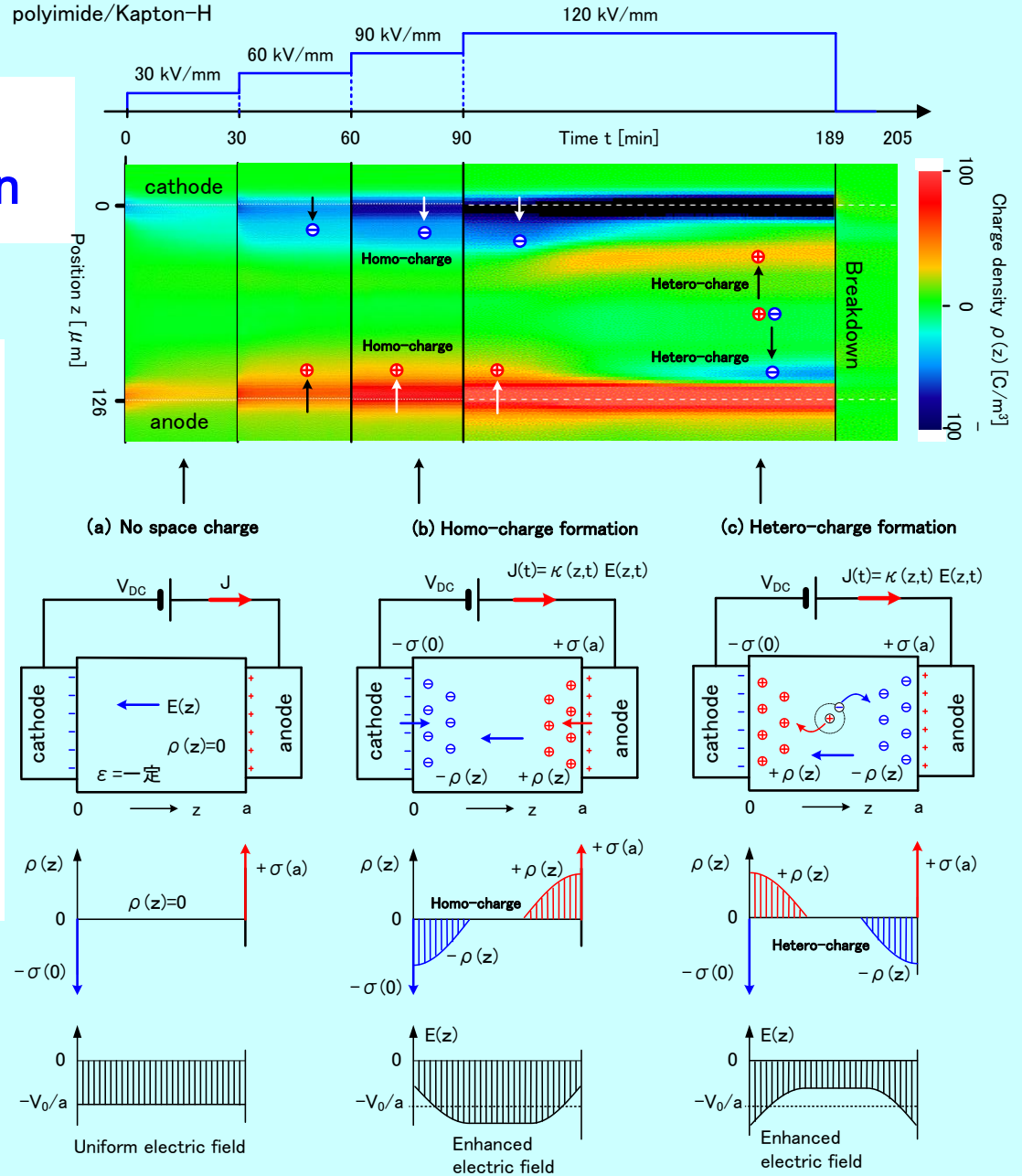

B : Measurements of Space Charge Accumulation / PEA & PWP

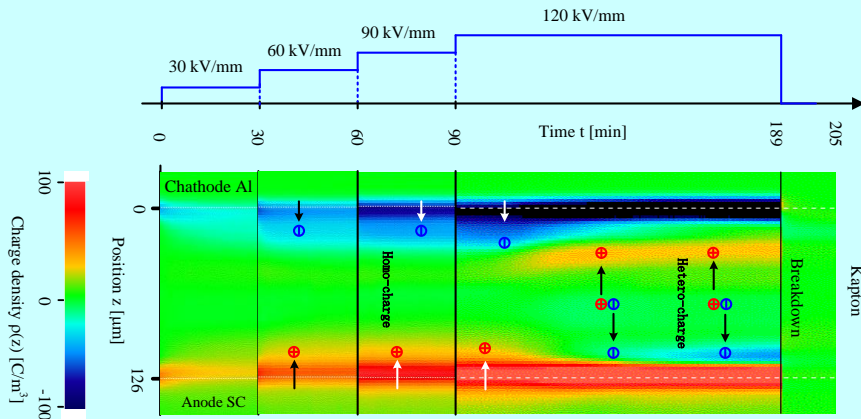

PEA measurement result of space charge accumulation in Kapton film under a different electric field and an elevated temperature.

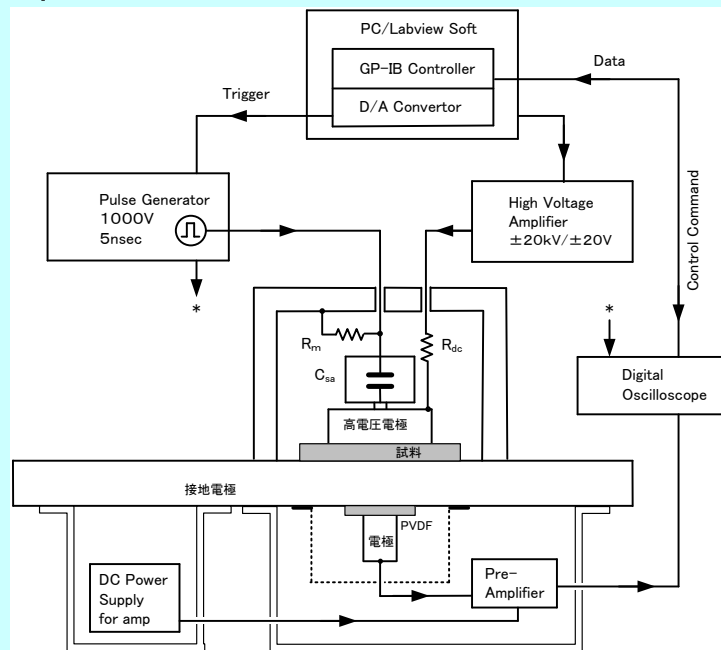

B-1 PEA space charge distribution measurement for sheet sample

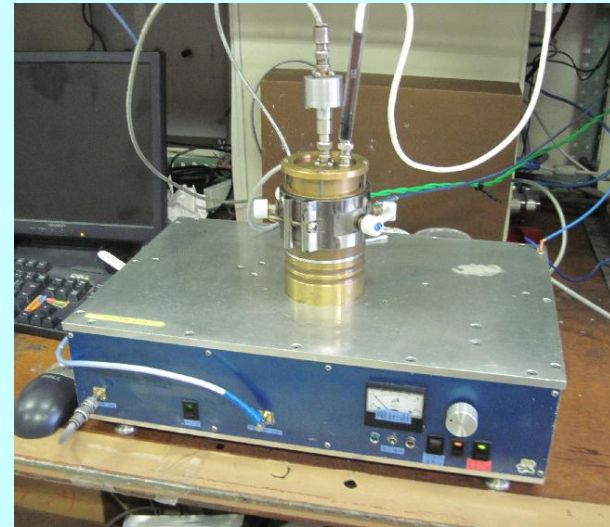

High temperature P E A system

P E A: Pulsed Electro-Acoustic method
PWP: Pressure Wave Propagation method

Ying Li and T. Takada, "Progress in Space Charge Measurement of Solid Insulating Materials in Japan," IEEE Electrical Insulating Magazine, Vol.10, No.6, pp.16-28, September/October (1994)

B-2 PEA measurement for Observing Charge Accumulation in Cross Section (r, θ) in Cable Geometry

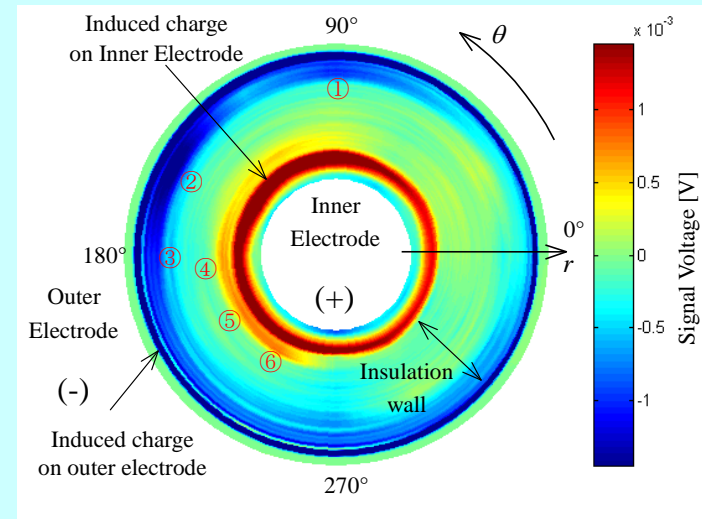
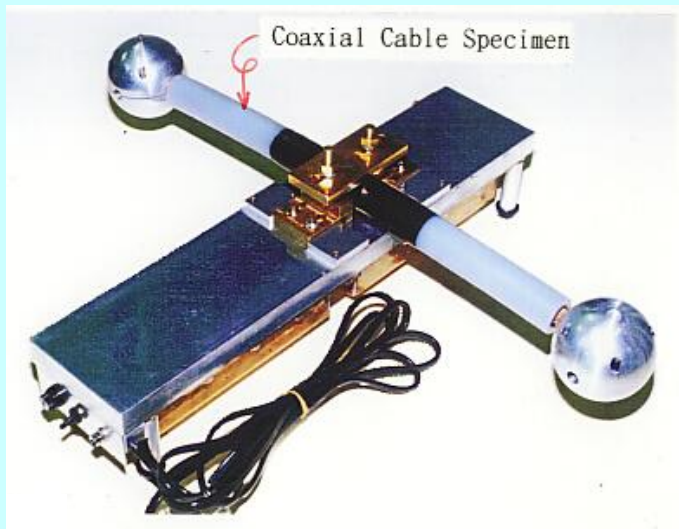
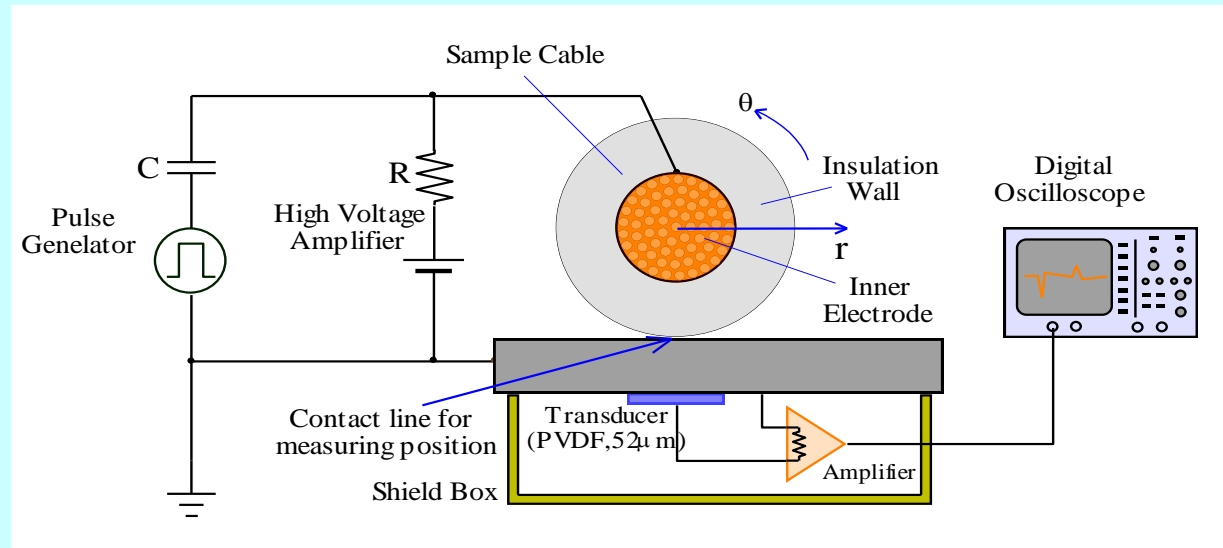

Measurement result of accumulated charge

Part 3 Analysis by Quantum Chemical Calculation

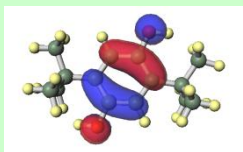

<Q(t) Measurement>

Measurement of basic electric properties

- Charge accumulation $\Delta Q(t)/Q_0$
- Conductivity κ [S/m]
- Dielectric constant ϵ_r

$Q(t)=Q_0+\Delta Q(t)$ measurement and

Evaluation of $\Delta Q(t)/Q_0$

- Electric field dependence
- Temperature
- Time dependence

<High temperature • space charge measurements>

- PEA measurement technology
- Charge density distribution measurement $\rho(x,t,T)$ [C/m³]

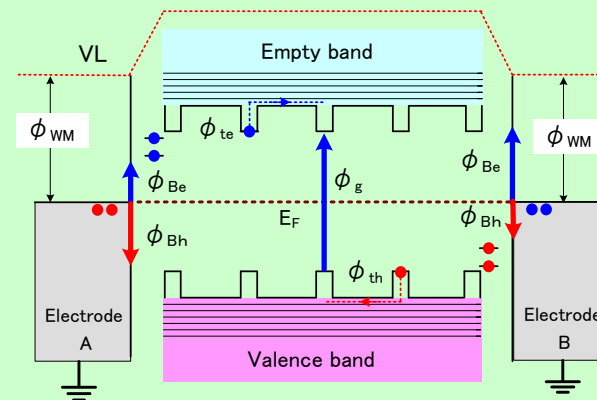
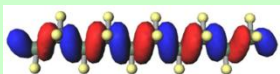

<Quantum Chemical Calculation>

Calculation of fundamental function for dielectric materials

- Energy gap ϕ_g
- Electrode charge injection barrier ϕ_B
- Charge trap depth ϕ_t

Consultant Contents

- Measurement technology of space charge accumulation in dielectric materials
- Evaluation and analysis of HVDC insulating materials in new energy power system.
- Evaluation and its analysis for high field DC insulating materials in a power electronic device.

<Mechanism of charge accumulation in dielectric materials>

- Dominant: electrode charge injection
- Dominant: electrode charge transfer
- Dominant: electrode charge generation

<Mechanism of insulation deterioration>

- Observation of energy level variation caused by charge accumulation
- Breaking the molecular chain by the accelerated electron under high electric field

C: Fundamental Electronic Parameters of Insulating Materials by using Quantum Chemical Calculation

Energy level distribution and related parameters

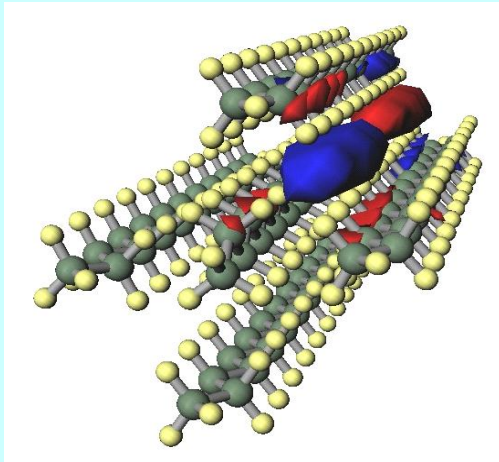

Molecular orbital of PE

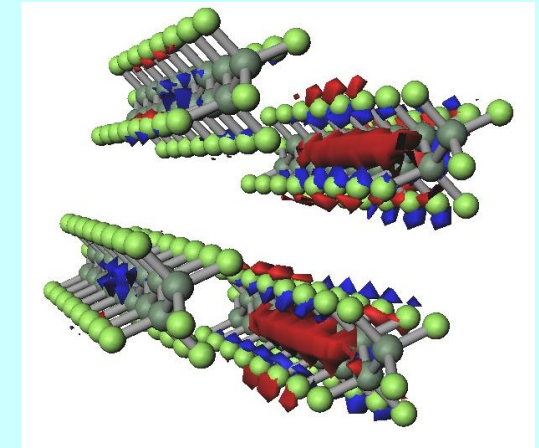
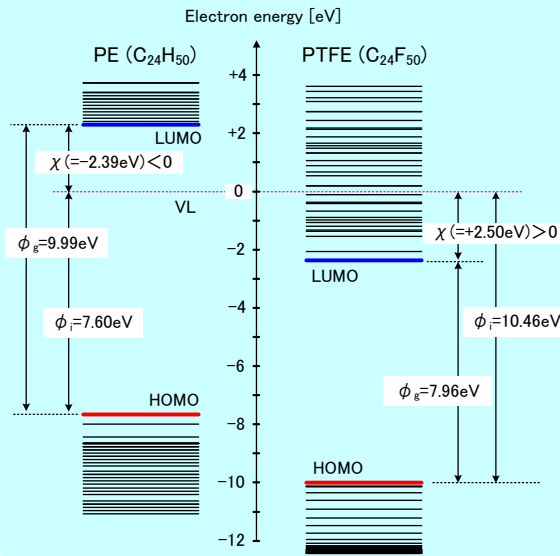

Molecular orbital of PTFE

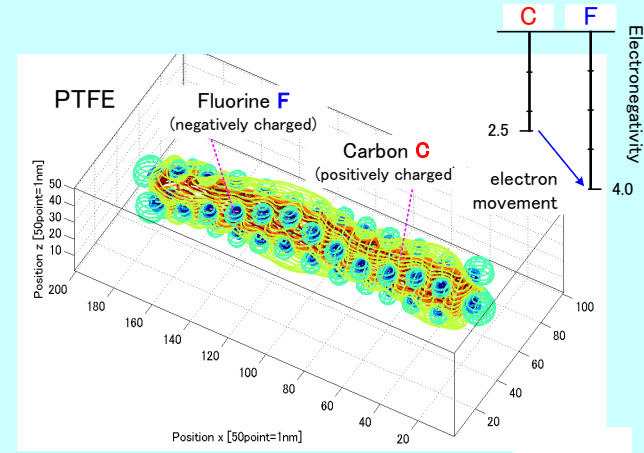
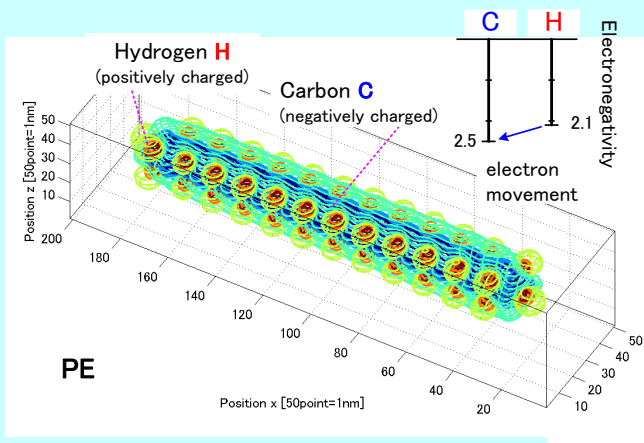

3-dimensional electro-static potential distribution

D: Analysis of Electric Charge Accumulation in Dielectrics

- Electron energy level distribution is calculated by Quantum Chemical Calculation. →
- Electron and hole trapping sites are introduced on the main chain which are determined by chemical molecular structure. →
- 3-dimensional electro-static potential distribution for positively and negatively charged chains was calculated by Quantum Chemical Calculation. →
- It is clearly found that the potential distortion is located at the estimated trapping sites on the chemical molecular structure.

Quantum Chemical Calculation is very useful to analyze the charge accumulation properties of insulating materials.

3D electro-static potential distribution for negatively charged PI/Kapton

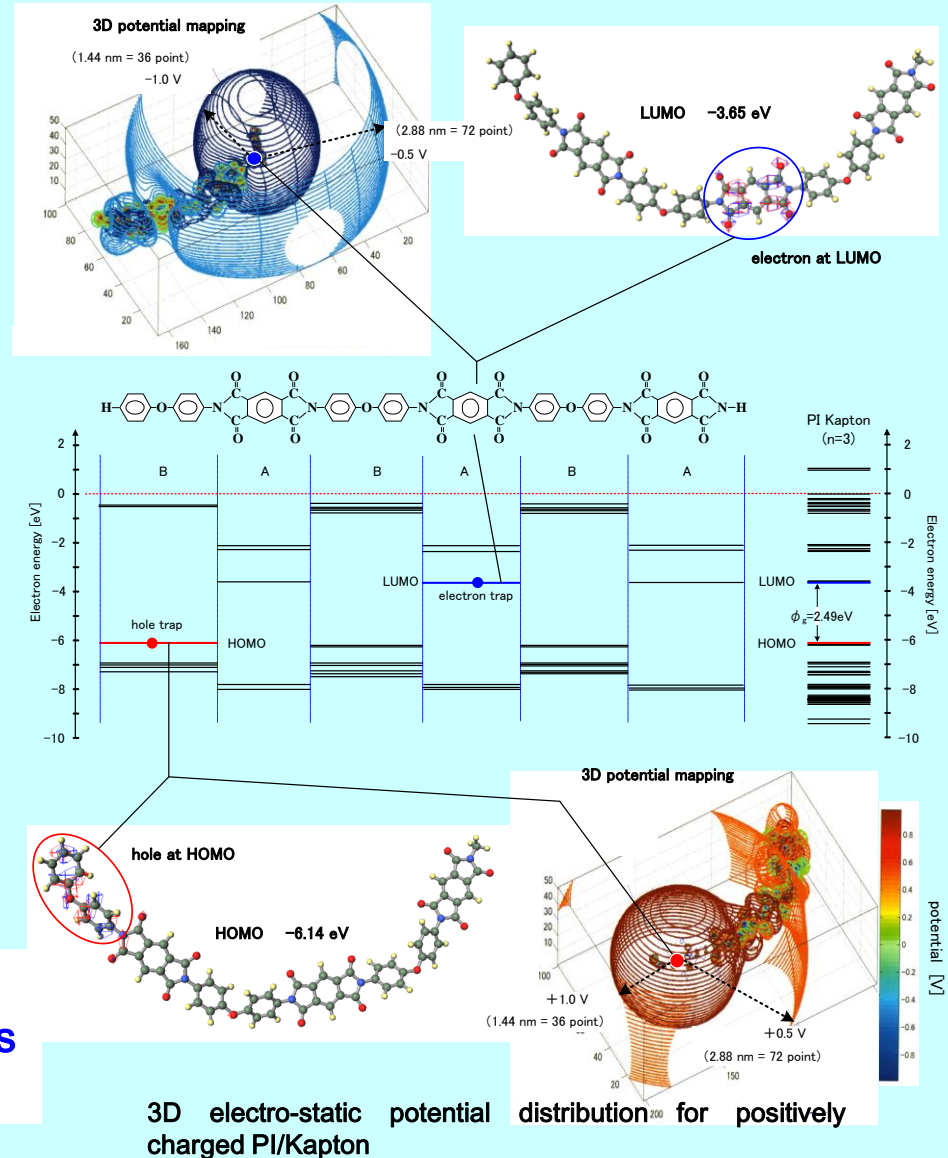

D: Analysis of Electric Charge Accumulation in Dielectrics

- Positive charge injection from anode into polyethylene under high electric field stress is observed by PEA method. →
- Why does the positive charge inject significantly in PE? →
- The barrier high (ϕ_B) of hole carrier is evaluated by using Quantum Chemical Calculation. →
- It is found that the hole carrier injection barrier from semi-conducting electrode is low, leading to the positive charge accumulation.

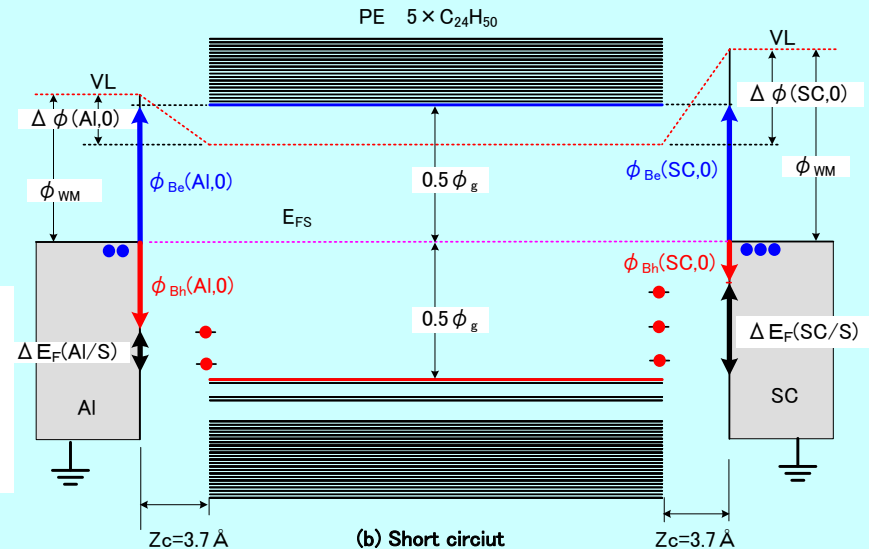
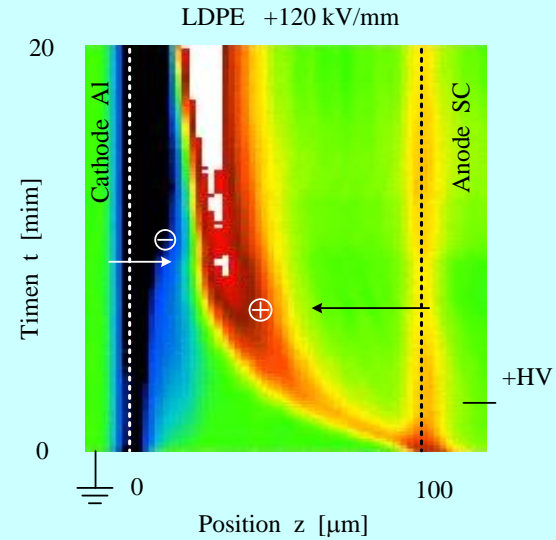

Key subjects:

□ PEA measurement

□ Quantum Chemical Calculation

Series of “Space Charge Accumulation in Dielectrics and Quantum Chemical Calculation Analysis”



Key issues for dielectrics investigation:

- (1) Classical theory of electro-magnetic and dielectric physics
- (2) Measurement technology and signal processing
- (3) Quantum chemical calculation.